

Protease synthase and sporulation protein PAI 2 (ENDGPEBD_00114)

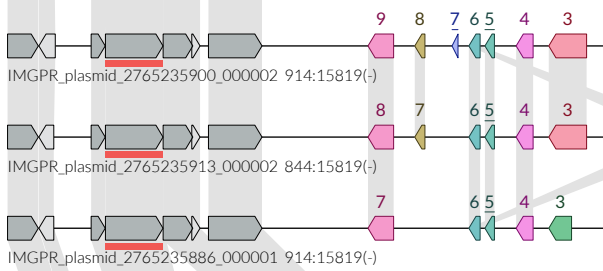

Insertion sequence IS5376 putative ATP-binding protein (FEOABMHO_00007)

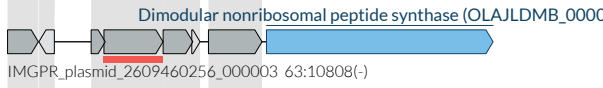
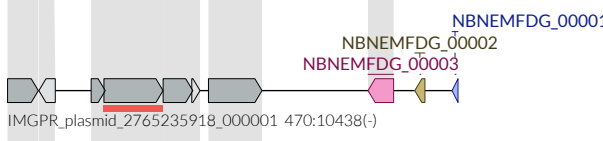
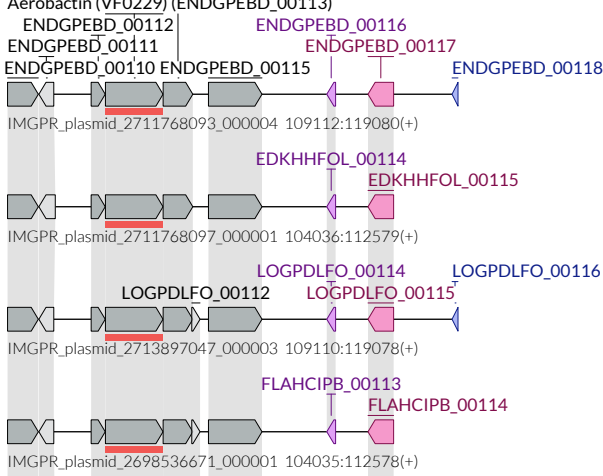
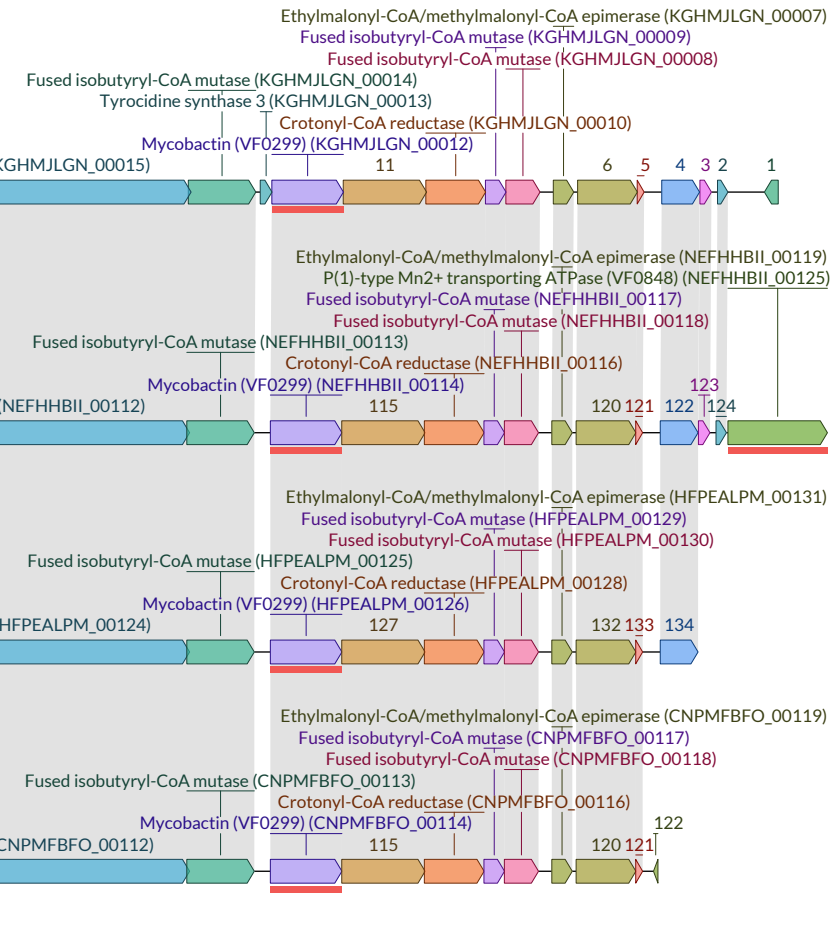
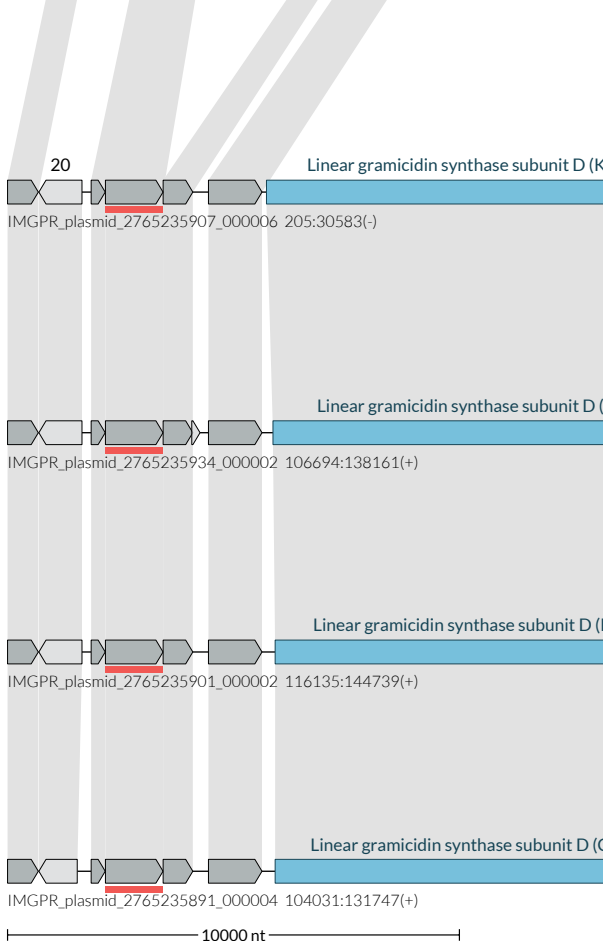
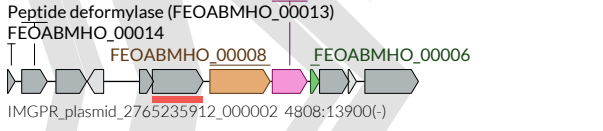

Virulence